

REFERENTIE TABEL H.O.H. MAAT

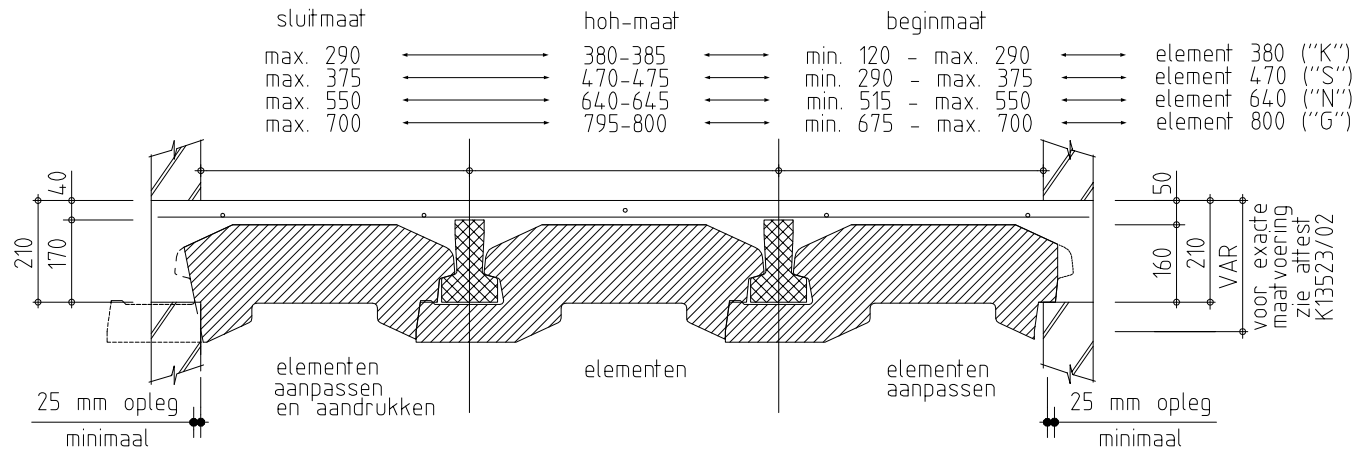

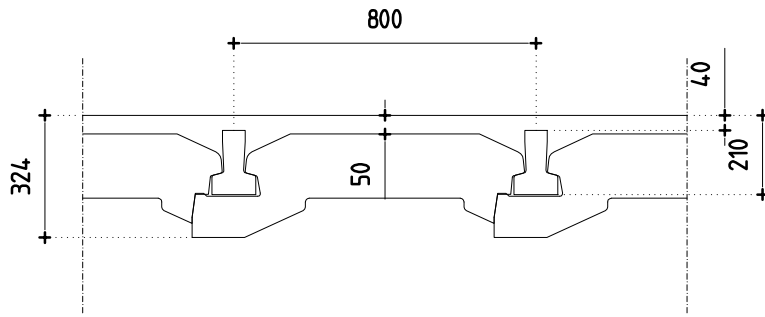

Element: 800-3.5 (G)

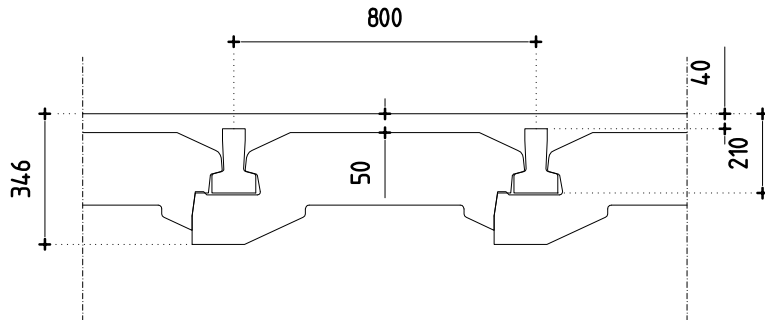

Element: 800-4.0 (G)

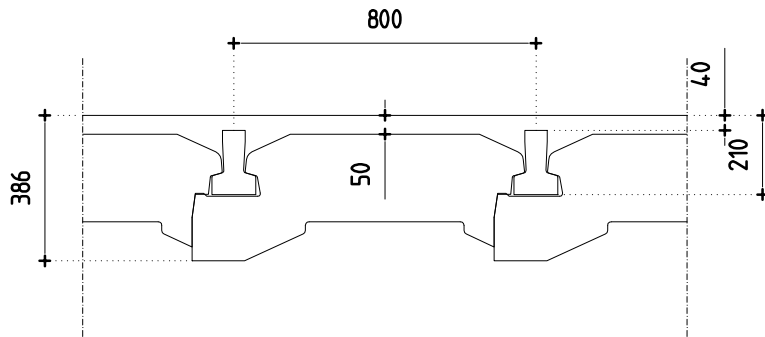

Element: 800-5.0 (G)

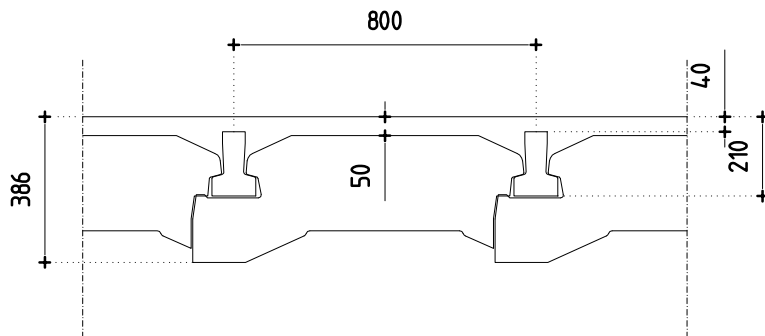

Element: 800-6.0 (G)

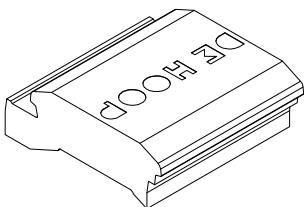

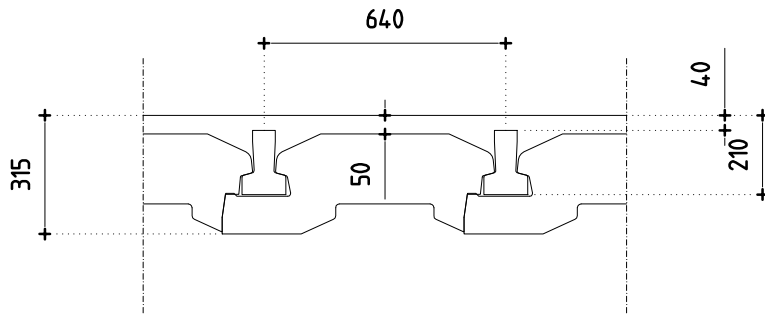

Element: 640-3.5 (N)

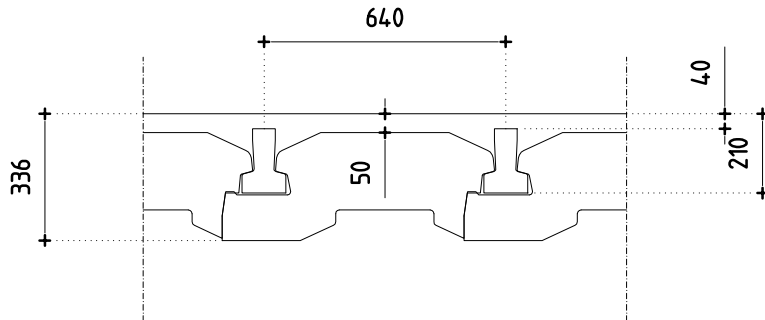

Element: 640-4.0 (N)

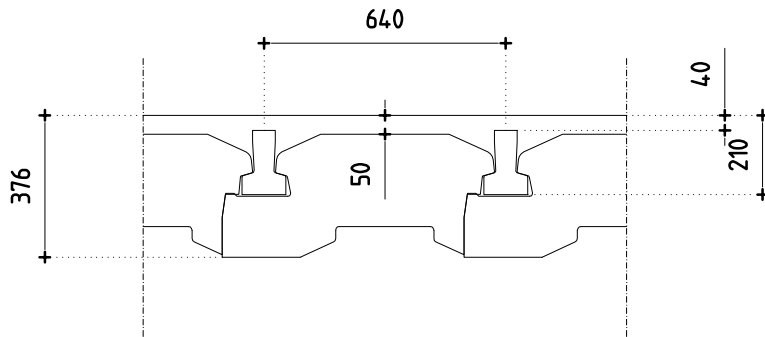

Element: 640-5.0 (N)

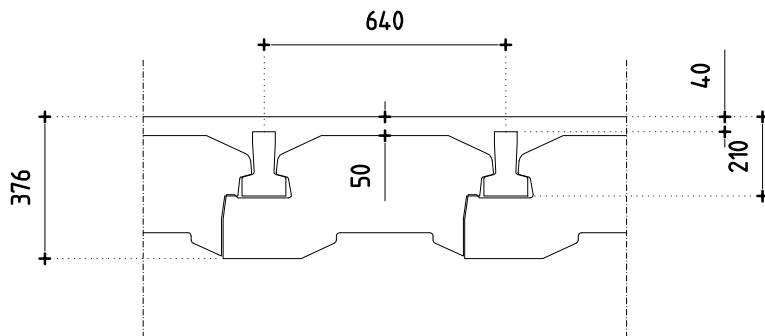

Element: 640-6.0 (N)

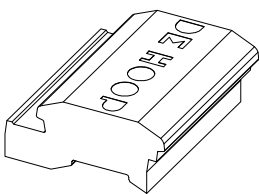

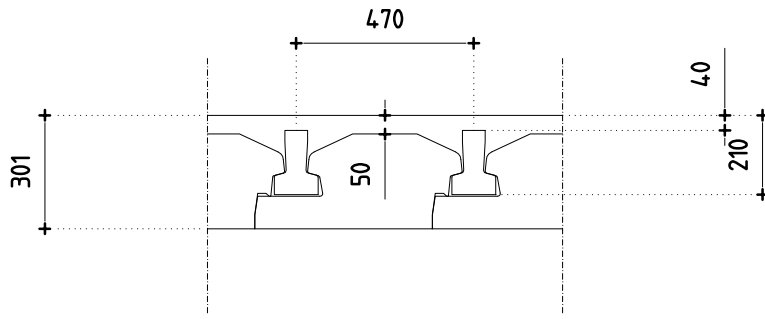

Element: 470-3.5 (S)

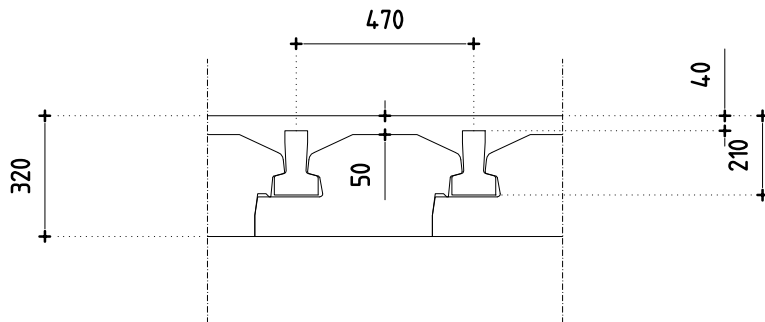

Element: 470-4.0 (S)

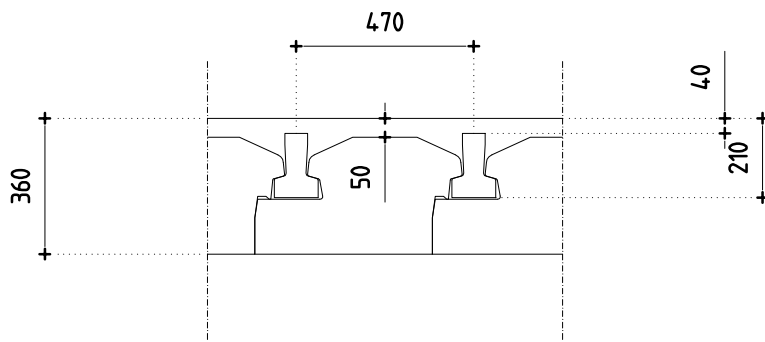

Element: 470-5.0 (S)

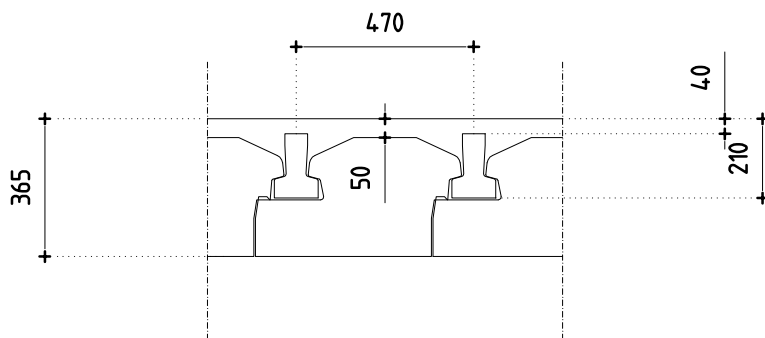

Element: 470-6.0 (S)

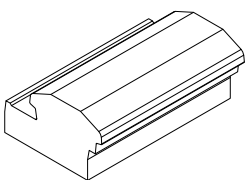

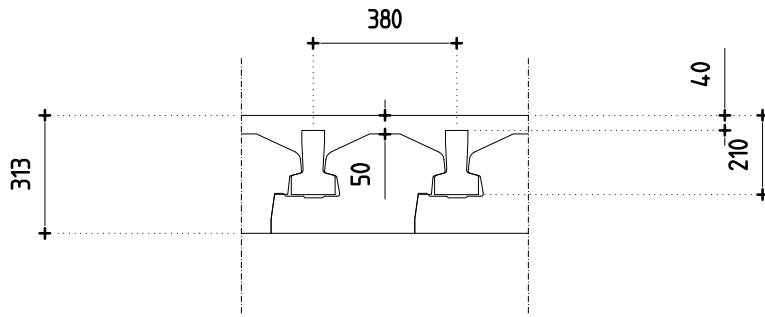

Element: 380-3.5 (K)

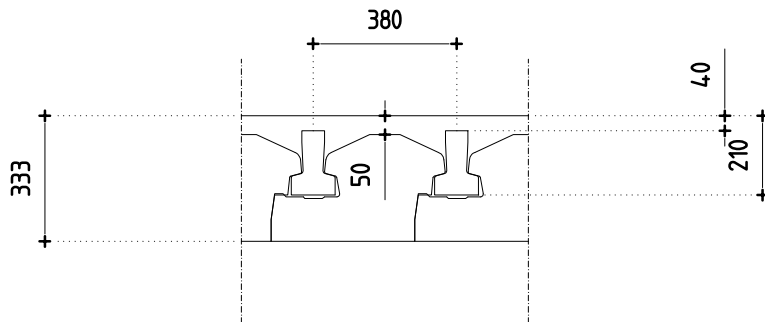

Element: 380-4.0 (K)

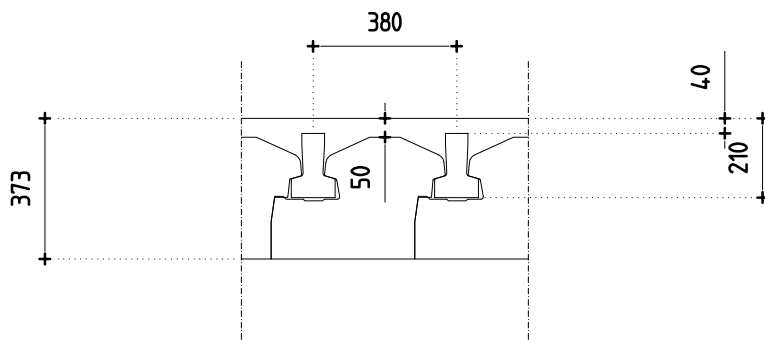

Element: 380-5.0 (K)

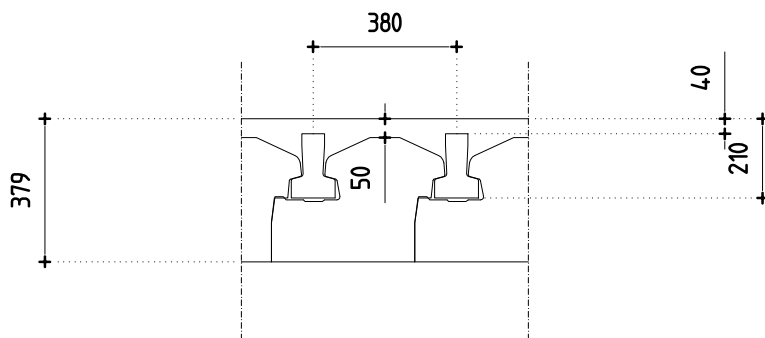

Element: 380-6.0 (K)

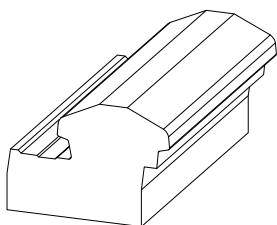

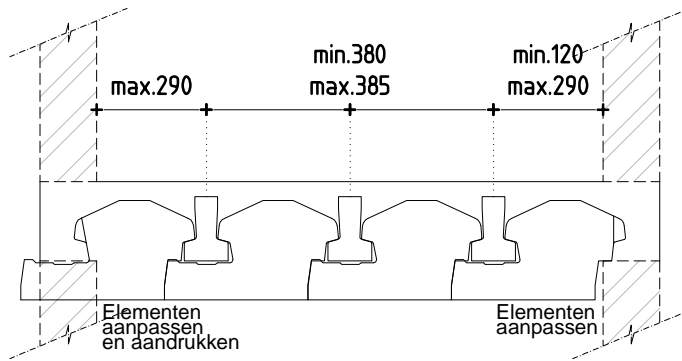

Element: 380 (K)

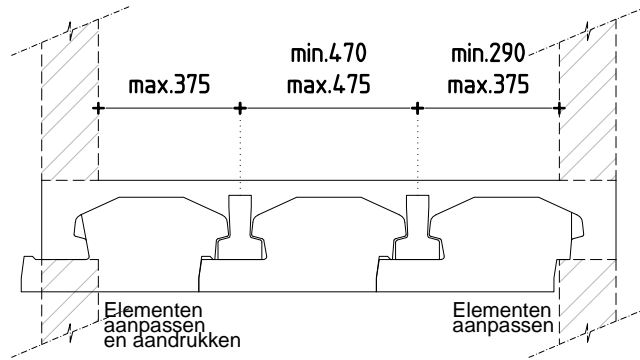

Element: 470 (S)

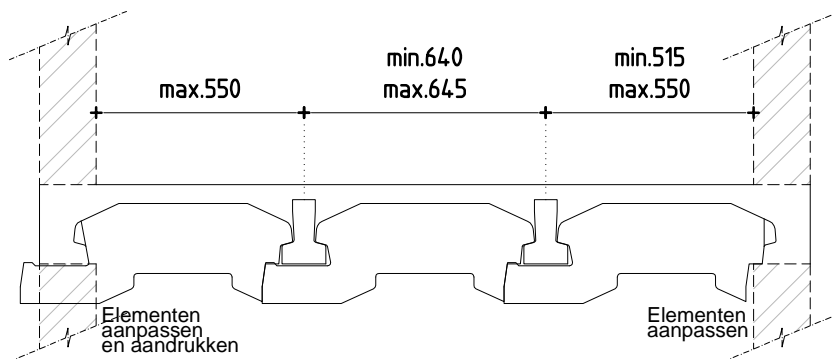

Element: 640 (N)

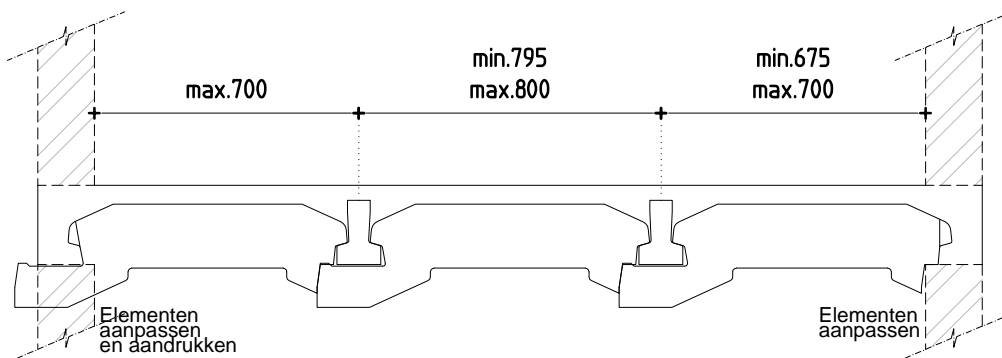

Element: 800 (G)



